

11-17

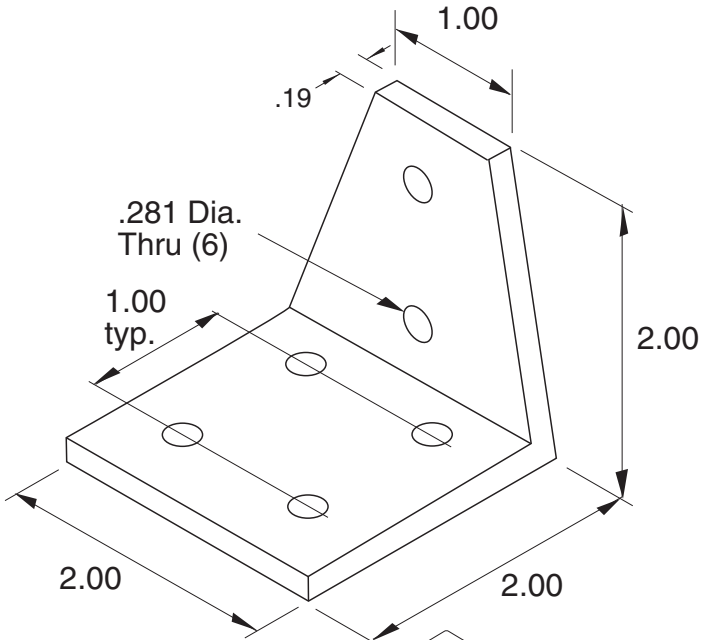

Recommended Hardware
(6) 11-231 BHCS
(6) 11-210 T-nut

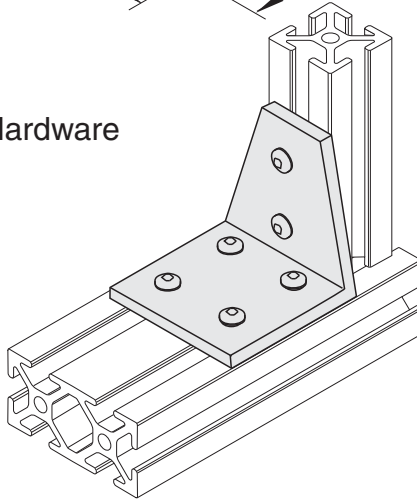

1/4" SLOTS

Material - Aluminum
Finish - Clear Anodize