

Joining Plate

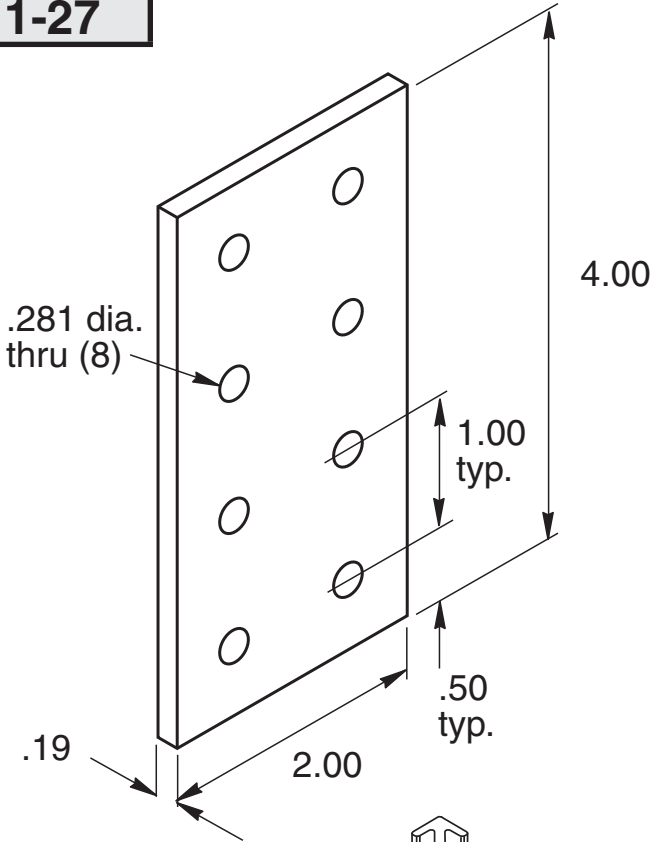

11-27



1/4" SLOTS

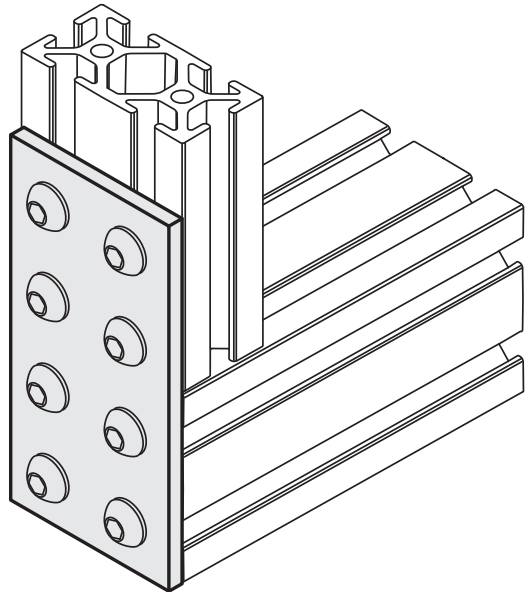

Recommended Hardware
(8) 11-231 BHCS
(8) 11-210 T-nut

Material - Aluminum
Finish - Clear Anodize