

11-37

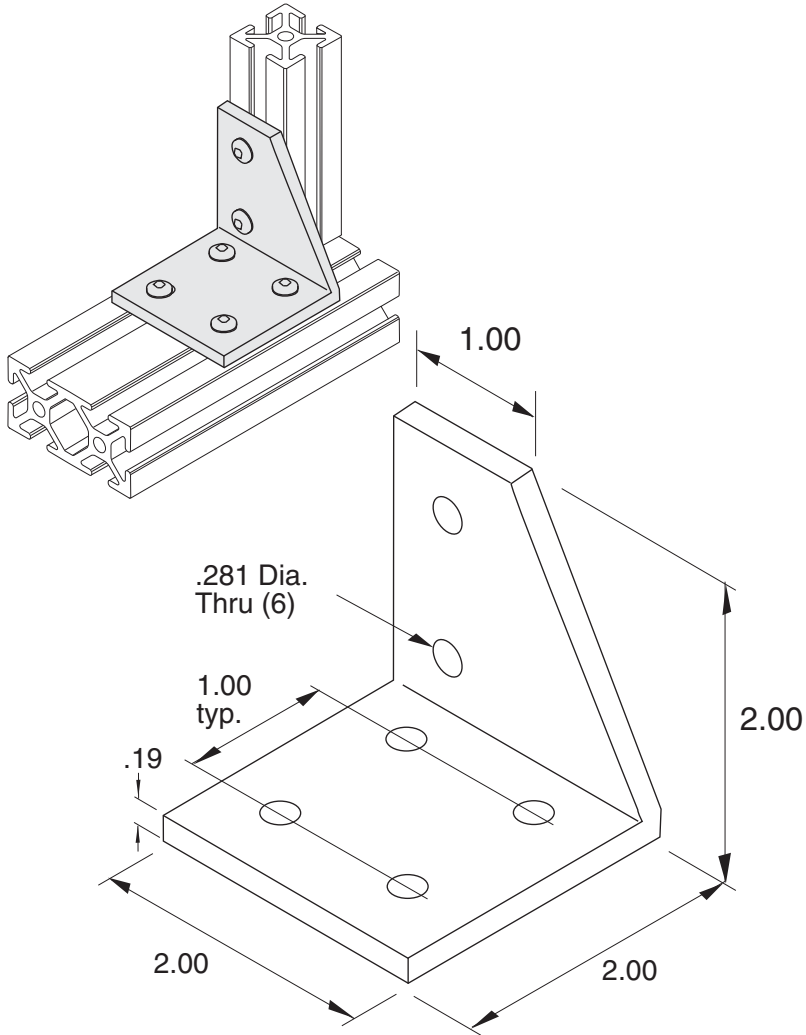

1/4" SLOTS

Recommended
Hardware
(6) 11-231 BHCS
(6) 11-210 T-nut

Material - Aluminum
Finish - Clear Anodize