

**11-39**

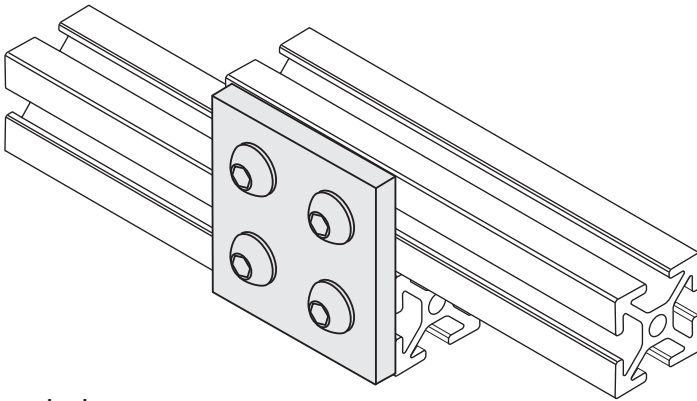
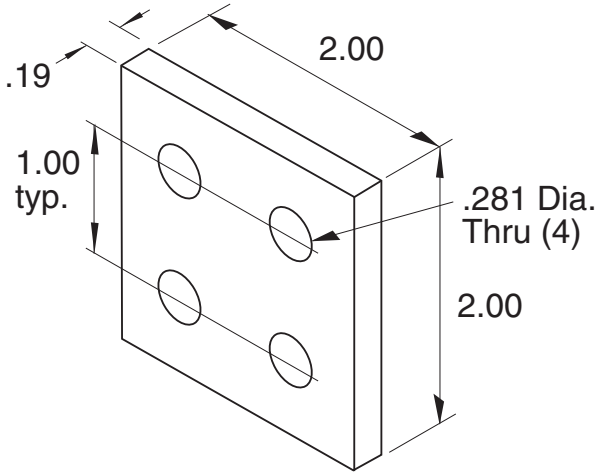

**1/4" SLOTS**

Recommended  
Hardware  
(4) 11-231 BHCS  
(4) 11-210 T-nut

Material - Aluminum  
Finish - Clear Anodize