

Conveyor Roller Mounting Block



EF-150
EF-151

5/16" profiles

1/4" profiles

5/16" SLOTS

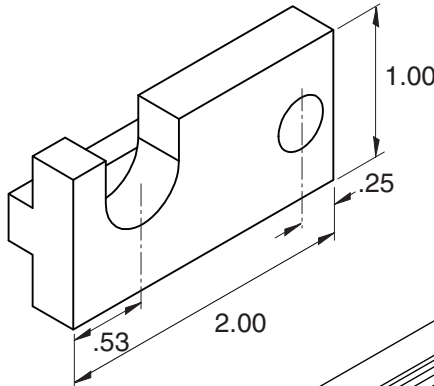

Axle size up to
7/16" hex or 1/2" round
Fasteners Included

Rollers can be put in or taken
out individually without taking
conveyor apart

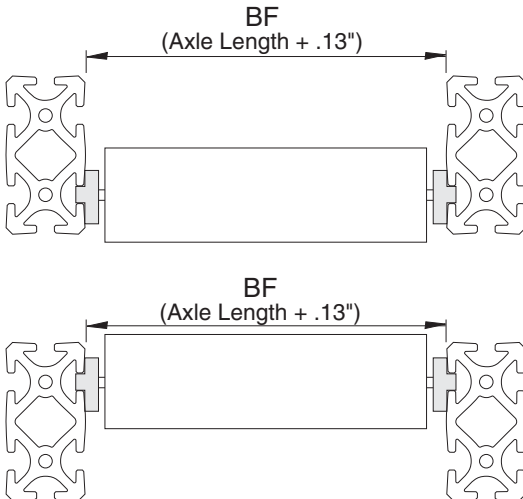
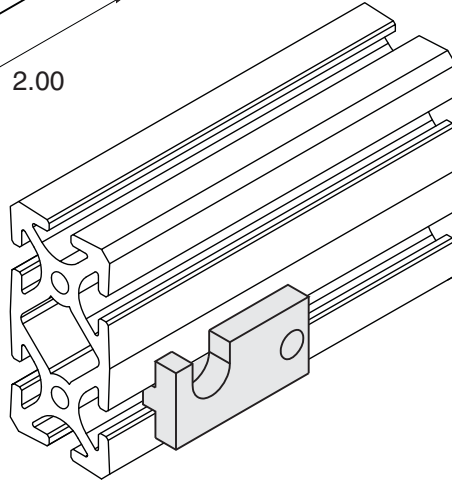

Roller Part no.	BF (Length between frame) Inches
EF-161	14.375
EF-162	20.375
EF-163	26.375
EF-166	14.375
EF-167	20.375
EF-168	26.375

Note: See page 277 for rollers.

Material - Aluminum
Finish - Clear Anodize